

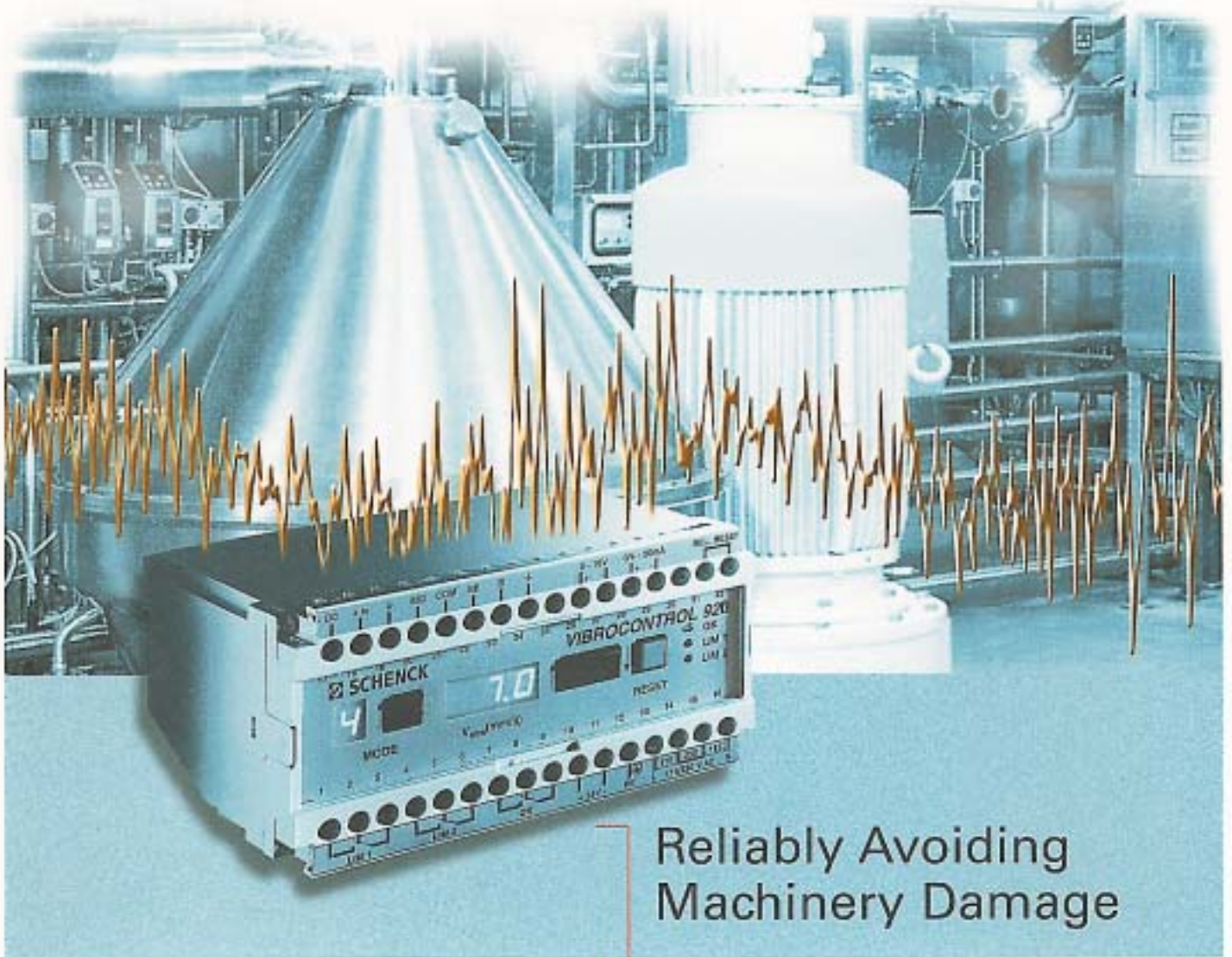

**Brüel & Kjær Vibro**



Reliably Avoiding  
Machinery Damage

## VIBROCONTROL 920

The Economic Vibration Monitor  
with Microprocessor Technology

# Using Vibration Condition Monitoring to avoid Machinery Failure

Machines are subject to many influences during operation which affect the condition of rotating machine components, bearings, machine housings and the foundations which can lead to expensive direct and consequential damage. The most common sources of machinery degradation due to vibration include:

- unbalance of the rotating machine components resulting from manufacturing errors, material distribution, wear etc.
- unbalance resulting from the uneven distribution of process or air-borne particle deposits on the blades of fans, blowers and air separators
- unbalance of centrifuges and separators through uneven process material distribution
- unbalance of wire-drums due to eccentric wrapping
- alignment errors as a consequence of mounting, thermal distortion of bearing pedestals or movement of the foundations
- bearing and gearing failure due to wear, fatigue or overload

Almost all sources of damage influence the "smooth running" of machines to some degree and subsequently lead to an increase in mechanical vibrations. Vibrations therefore can be considered as a dependable indicator as to the condition of not only the individual machine elements, but also the complete machine "health".

Implementation of vibration condition monitoring is recommended in order to recognise every change in the machine condition with a high level of reliability,

With a minimum of expenditure, in both time and investment, pending failure may be detected with the aid of vibration condition monitoring early enough so that the high costs of damage, consequential damage and production losses can be avoided, and that personnel safety and the machine environment are not compromised.

## VIBROCONTROL 920 the inexpensive Vibration Condition Monitoring System

VIBROCONTROL 920 is the powerful yet inexpensive solution to monitor the absolute vibration of bearings, housings, fans, blowers, mills, wire-drums, centrifuges, separators etc.

In accordance with:

- VDI-Richtlinie 2056 "Beurteilungsmaßstäbe für mechanische Schwingungen von Maschinen" (Machinery mechanical vibration classification guide lines),

and

- ISO-Standard 2372 "Mechanical vibration of machines with operating speeds between 10 to 200 rev/s"

the instrument measures the effective velocity (RMS value of vibration velocity) of the machine being monitored. The overall value corresponding to the machine condition is constantly monitored and compared with two previously set limit values. If the limit values are exceeded, corresponding relay switches are activated accordingly which further activate warnings or can be used, for example, to shut the machine down. The limit value settings are determined by:

- the recommended values as specified in the above mentioned standards
- the original equipment manufacturer vibration limit values
- experience applicable to the machine.

As a result of permanently monitoring the machine, all changes that are considered dangerous to the condition of the machine are reliably detected and a message prompted regardless of whether the cause is gradual through wear or corrosion, or whether an instantaneous increase resulting from material fracture or break away of rotor assemblies has occurred.

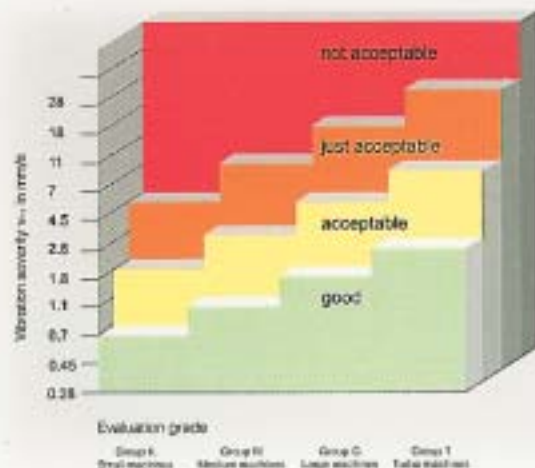

# Reliable and user friendly through Microprocessor technology

As for all Schenck products, VIBROCONTROL 920 possesses excellent quality, a high level of reliability and implements the most modern of technologies. The instrument is equipped with a powerful microprocessor that

increases the level of monitoring reliability and measurement processing. System configuration, either during commissioning or any subsequent service work, may easily be performed while the instrument is in operation as

a result of the computer supported data processing. Presented below are some of the VIBROCONTROL 920 characteristics worthy of note:

- exceptional price - capability relationship
- simple and cost-saving installation
- software settings of:
  - measurement range
  - frequency range
  - limit values
  - limit value relay delay
  - low or rated current relay switching
  - plotter connection etc.
- alarm signalling via two powerful switch relays when limit values are exceeded
- display of the measured value and the amount that a limit value has been exceeded
- connections for register and diagnostic instruments
- self diagnosis of the supply voltage, microprocessor and the vibration transducers via OK relays
- automatic display of error messages
- use of either vibration velocity or acceleration transducers
- vibration transducers for use in explosive environments are available
- long guarantee time

## VIBROCONTROL 920 is simple to install

VIBROCONTROL 920 consists of two main components:

- a vibration transducer, and
- an electronic condition monitoring instrument

The vibration transducer converts the mechanical vibrations into electrical signals. The transducer is mounted directly onto the machine housing, preferably in the vicinity of a bearing location, and connected to the electronic condition monitoring instrument. Subject to requirements either:

- electrodynamic vibration velocity transducer, or
- piezoelectric acceleration transducer with an in-built charge amplifier can be connected.

Both of these transducers are supplied with either M8 or M10 centrally threaded holes for permanent mounting to the machine. The connection cable subject to the transducer type is either 5 or 10 m long, although lengths of up to 300m can also be supplied. Signal cable and junction boxes are available as optional.

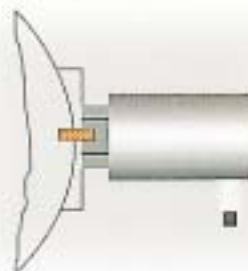

The electronic condition monitoring instrument uses the signal from the vibration transducer to determine the overall vibration velocity levels and monitors these with respect to the set limits and responds accordingly with

messages or relay action when these limits are exceeded. The electronics is built into a plastic housing, the design of which is intended for mounting into a control cabinet. Mounting may either be:

- directly onto profile rails, or
- bolting to a switch cabinet mounting plate.



The configuration of the condition monitoring equipment is performed via software dialogues, without wire bridges or switches and can be performed typically within five minutes.

# Technical Data

## Monitoring Electronics

- **Measured Parameter**  
Effective Velocity (RMS) in mm/s  
(in/s peak)
- **Measurement input**  
1, configured for  
- acceleration transducer with  
supply of voltage or current  
- vibration velocity transducer
- **Measurement range**  
0... 10/20/50/100 mm/s  
(0... 0.4/0.8/2.0/4.0 in/s)
- **Frequency range**  
selectable  
10... 1000 Hz (-3dB)  
1... 1000 Hz (-3dB), only with acce-  
leration transducer AS/ASA, back-  
ground noise 0.15 mm/s (0.006in/s)
- **Limit values**  
2, software adjustable
- **Signal Response Delay**  
for limit values 1 & 2: 0... 99 s
- **Self Monitoring**  
Error messages with separate OK  
relays
- **Diagnostic Signal Outputs**  
Buffered transducer signal
- **Limit and OK Relays**  
3 mains current each with 1 switch  
contact. Power requirements:  
100 W / 600 VA max. 30V DC or  
300V AC, 3A, 3 LED status display
- **Analogue output**  
0 - 10V load resistance > 100 k $\Omega$   
0/4 - 20mA, shunt resistor < 500  $\Omega$
- **Power supply**  
230/117 V, AC  $\pm$ 15%, 41... 62 Hz  
max. 12 W or 18... 32V DC
- **Ambient temperature**  
-10... +55 $^{\circ}$  C (14... 130 $^{\circ}$  F)
- **Housing**  
Plastic, IP 20
- **Weight (without cable)**  
approx. 1kg (2.2 lb.)

## Vibration Transducers

- **Acceleration transducer - standard application**  
**AS-022**  
Threaded stud mounting, radial  
cable, 5 m PVDF cable, with pig  
tails  
**AS-030**  
Threaded stud mounting, axial  
cable with FAST-ON connectors
- **Acceleration transducer - explosion proof**  
**ASA-022**  
E Ex ib III C T 6/5/4. Design as for  
AS-020, explosion protection only in  
combination with Zener safety  
barrier AC-293
- **Acceleration transducer data**  
**Measurement direction**  
any  
**Sensitivity**  
100mV/g  $\pm$ 5%  
**Overload**  
Continuous: 500 g (peak)  
Shock: 5000 g (peak)  
**Power requirements**  
-18... 30V DC  
**Ambient temperature**  
-50... +125 $^{\circ}$  C (-60... 260 $^{\circ}$  F)  
**Housing**  
Stainless steel, IP 66 (not AS-030)  
**Weight incl. cable**  
approx. 300 g (10.6 oz.)
- **Velocity transducer - standard appli-  
cation**  
**VS-068**  
horizontal measuring direction  
**VS-069**  
vertical measuring direction  
**Cable:**  
2 conductor Teflon, 5 m with pig  
tails and steel protective conduit
- **Velocity transducer - explosion  
protection**  
**VS-168**  
horizontal measuring direction  
**VS-169**  
vertical measuring direction  
**E Ex d IIC T6**  
Explosion protection only in combi-  
nation with safety module AC-506  
**Cable:** 3 conductor PVC, 10 m, (N)  
YLHCY-J with pig tails
- **Velocity transducer data**  
**Sensitivity**  
100 mV / mm/s  $\pm$ 5%  
**Max. allowable vibration  
displacement**  
 $\pm$ 0.45 mm (0.018 in.)  
**Ambient temperature**  
VS-068/069: -40... +100 $^{\circ}$  C  
(-40... 212 $^{\circ}$  F)  
VS-168/169: -15... +65 $^{\circ}$  C (5...150 $^{\circ}$  F)  
**Housing**  
Stainless Steel  
VS-068/069 IP 66  
VS-168/169 IP 65  
**Weight incl. cable**  
approx. 1.25 kg (2.8 lb)

# Dimensions

## Monitoring Electronics

Dimensions in mm

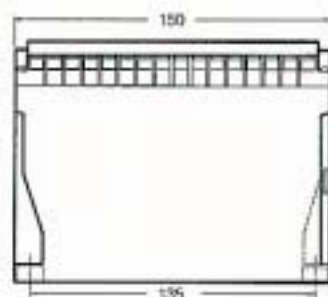
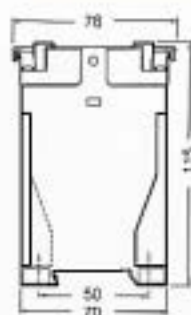
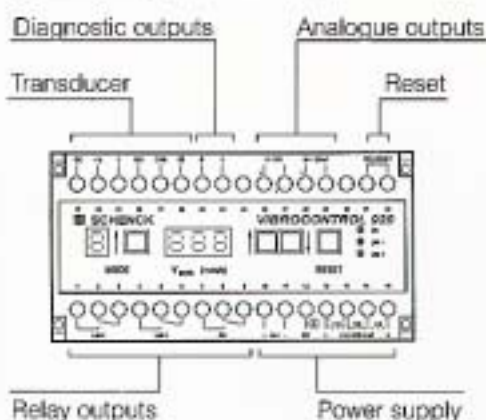

## Vibration Transducers

VS-068/VS-069

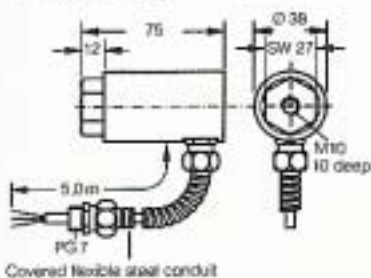

VS-168/VS-169

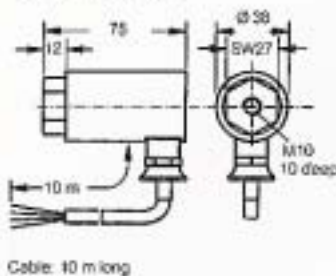

AS-022  
ASA-022

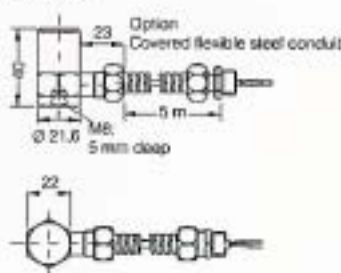

AS-030

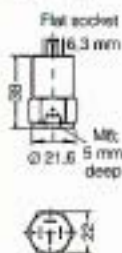

## Junction Boxes

AC-221

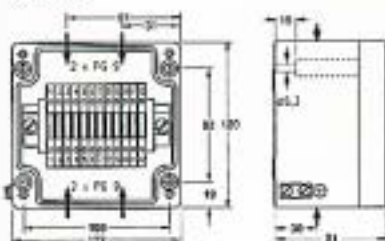

AC-178

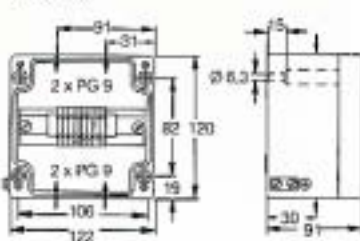

AC-196

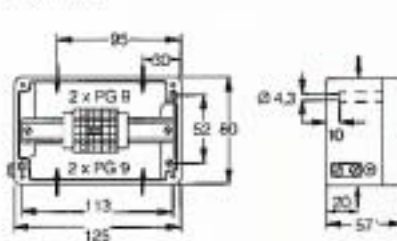

# Delivery details and Ordering information

## 1. Condition Monitoring Electronics

consists of:

- 1 Vibration condition monitoring instrument VIBROCONTROL 920 complete with two operator manuals in either German, English or French languages (please indicate the language required)

## 2. Vibration Transducers

- Acceleration transducer- standard application

**AS-022**

for use in any measurement direction, 5 m cable

**AS-030**

for use in any measurement direction, without cable, with FAST-ON connectors

- Acceleration transducer - explosion protection

**ASA-022**

for use in any measurement direction, 5m cable, Explosion protection E Ex ib II C T 6/5/4

**AC-293**

Safety barrier module for acceleration transducer ASA-022

- Velocity transducer - standard application

**VS-068**

for horizontal measuring direction, 5 m cable

**VS-069**

for vertical measuring direction, 5 m cable

- Velocity transducer - explosion protection

**VS-168**

for horizontal measurement direction, Explosion protection E Ex d IIC T 6

**VS-169**

for vertical measuring direction, 10m cable, Explosion protection E Ex d II C T 6

**AC-506**

Safety module for velocity transducers VS-168/169

## 3. Junction Boxes

- Supplied in a robust aluminium housing conforming to IP 65 standards, painted RAL 7001, with cable feed-through connection

Standard applications

**AC-221**

for max. 2 vibration transducers VS-068/069 or AS-022/030

Weight: approx. 1,25 kg (2,8 lb.)

Explosion protection

**AC-178**

for max. 2 acceleration transducers ASA-022, Explosion protection E Ex i  
Weight: approx. 600 g (1.3 lb.)

**AC-196**

for max. 2 velocity transducers VS-168/169, Explosion protection E Ex e  
Weight: approx. 650g (1.4 lb.)

## 4. Signal cable

- Standard applications

**AC-112**

for vibration transducers AS-022/030 and VS-069/069, shielded, 4 x 0.5 mm<sup>2</sup>, PVC, black, LIY (ST), Ø 7 mm, Temp. -20... +70° C (-4... 160° F)

Explosion protection

**AC-114**

for acceleration transducer ASA-022, Explosion protection E Ex i, shielded, 4 x 0.5 mm<sup>2</sup>, PVC blue, LIY (ST)Y, Ø 7 mm, Temp. -20... +70° C (-4... 160° F)

**AC-186**

for velocity transducers VS-168/169, Explosion protection Ex E e, shielded, 2 x 0.75 mm<sup>2</sup>, PVC, grey, Ø 7 mm, Temp. -10... +80° C (14... 175° F)

Further details of vibration transducers and accessories upon request.

Brüel & Kjær Vibro A/S  
Linde Allé 5A  
2850 Nærum  
Denmark  
Tel.: +45 45 80 05 00  
Fax: +45 45 80 29 37  
E-Mail: info@bkvibro.com  
Internet: www.bkvibro.com

Brüel & Kjær Vibro GmbH  
Leydheckerstraße 10  
64293 Darmstadt  
Germany  
Tel.: +49 (0) 6151 - 428 - 11 00  
Fax: +49 (0) 6151 - 428 - 12 00  
E-Mail: info@bkvibro.de  
Internet: www.bkvibro.com